

## **H122 Focus Drive Installation**

The following instructions refer to the standard split sleeve mounting.

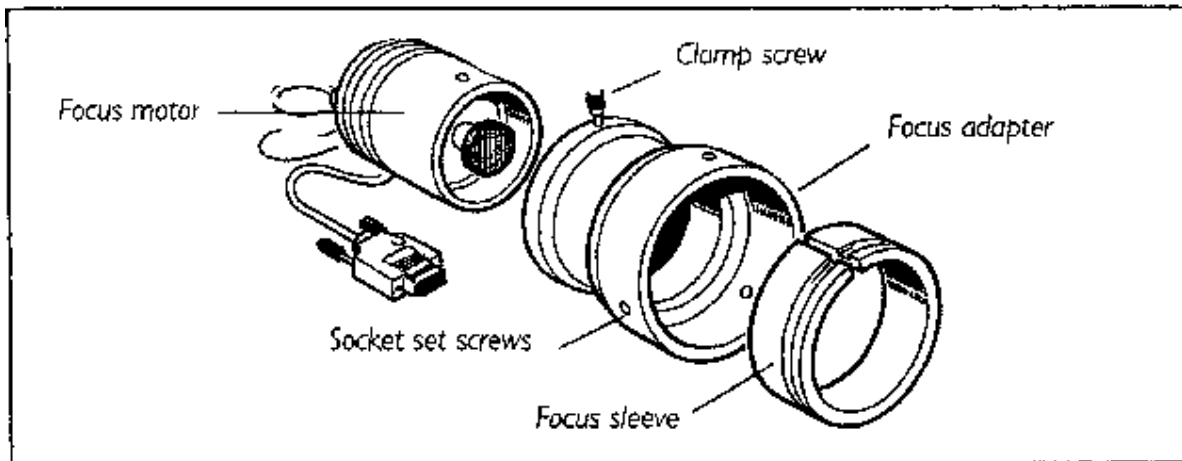

1. Loosen the clamp screw on the focus motor assembly and remove the focus motor from the focus adapter.
2. Loosen the 3 socket set screws around the periphery of the focus adapter using a 2mm Allen wrench until the focus sleeve is able to fit inside the adapter. Note that it is important to insert the sleeve in the correct orientation with the lip furthest inside the adapter (the chamfered edge of the sleeve will be inserted first). Note the orientation of the sleeve as it has a recess around its outer surface, which will hold the sleeve in when the setscrews are tightened. This recess must line up with the tips of the socket set screws.
3. With the sleeve in place, tighten the 3 socket set screws in sequence until they all just touch the sleeve, ensuring that the split in the sleeve does not line up with any of the set screw positions. **DO NOT TIGHTEN UP ANY OF THE SETSCREWS AT THIS STAGE.**

4. Push the adapter onto the preferred coarse knob of the microscope as far as it will go. **The controller is factory configured to drive the focus motor in the correct direction when mounted to the right hand side of an upright microscope. If the left hand coarse control knob is preferred by the user or the focus drive is to be mounted on an inverted microscope, the motor direction can be reversed by using a PC with a terminal emulation program e.g. HyperTerminal and changing the settings of the ZD command (see section 6) via RS232 communication.**

The inside fitting diameter of the sleeve is designed to be slightly larger than the coarse knob, provided the setscrews have not been tightened and are compressing the sleeve.

5. While holding the adapter in place, tighten the set screws in sequence only enough to secure the unit onto the coarse focus knob. The focus knob will have to be rotated to gain access to all of the screws.

6. Check that the unit has been tightened sufficiently by taking hold of it and turning it. If the adapter is correctly fitted it will stay attached to the coarse knob.

7. Slide the focus motor into the adapter as far as it will go and while applying gentle pressure to the motor tighten the clamp screw. This will hold the motor in place. The rubber drive bush on the end of the motor spindle should now be pressing against the end surface of the fine focus control knob. This can be confirmed by manually rotating the exposed fine focus knob on the opposite side of the microscope and feeling for the resistance caused by the detent positions of the stepper motor as it rotates. This will not cause any damage to the focus motor

8. Confirm that the controller is switched off before connecting the 9 way D type plug on the focus motor lead to the socket on the rear of the controller.

H122KON and H122KOL1 Coupler Installation Instructions

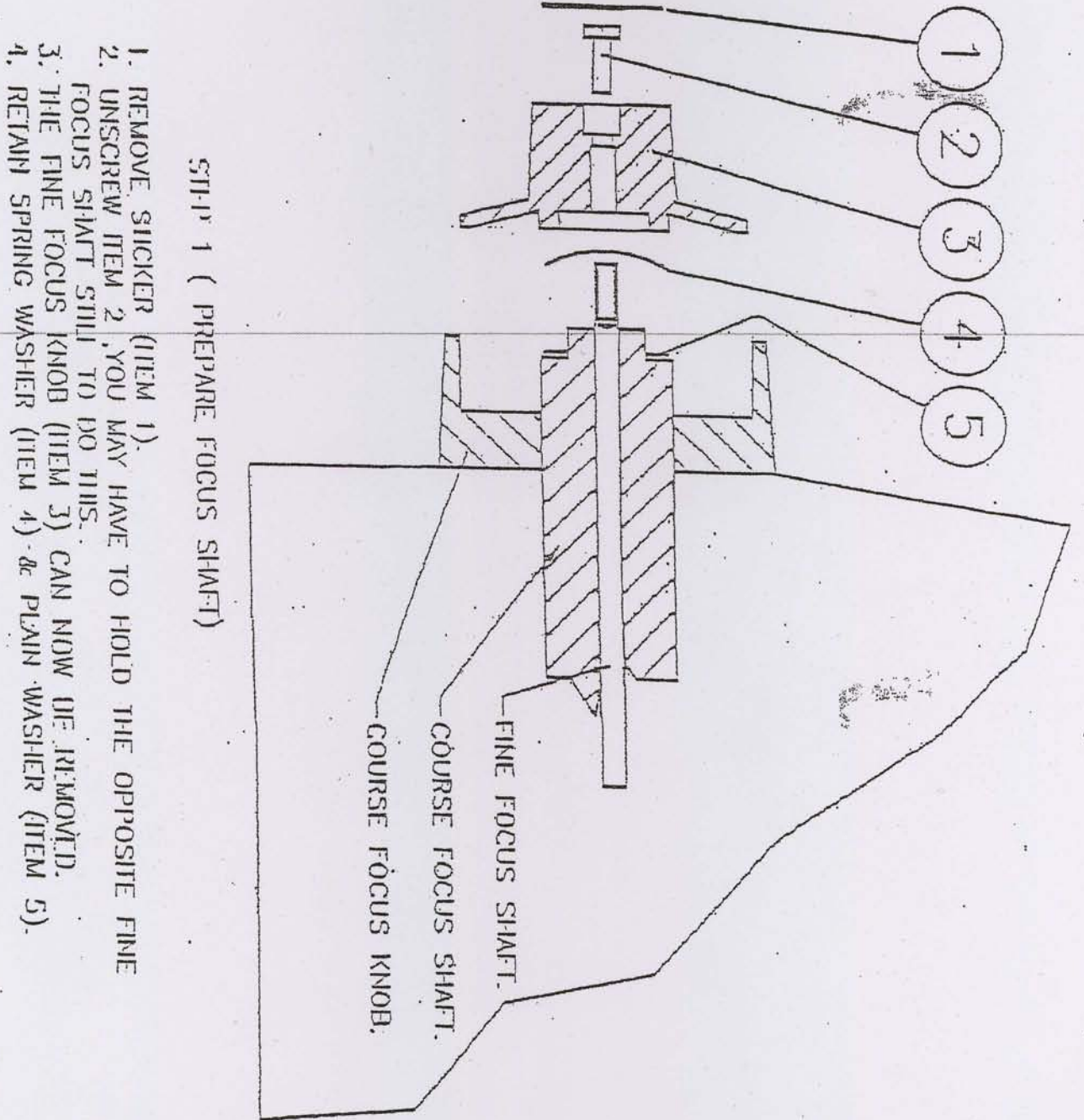

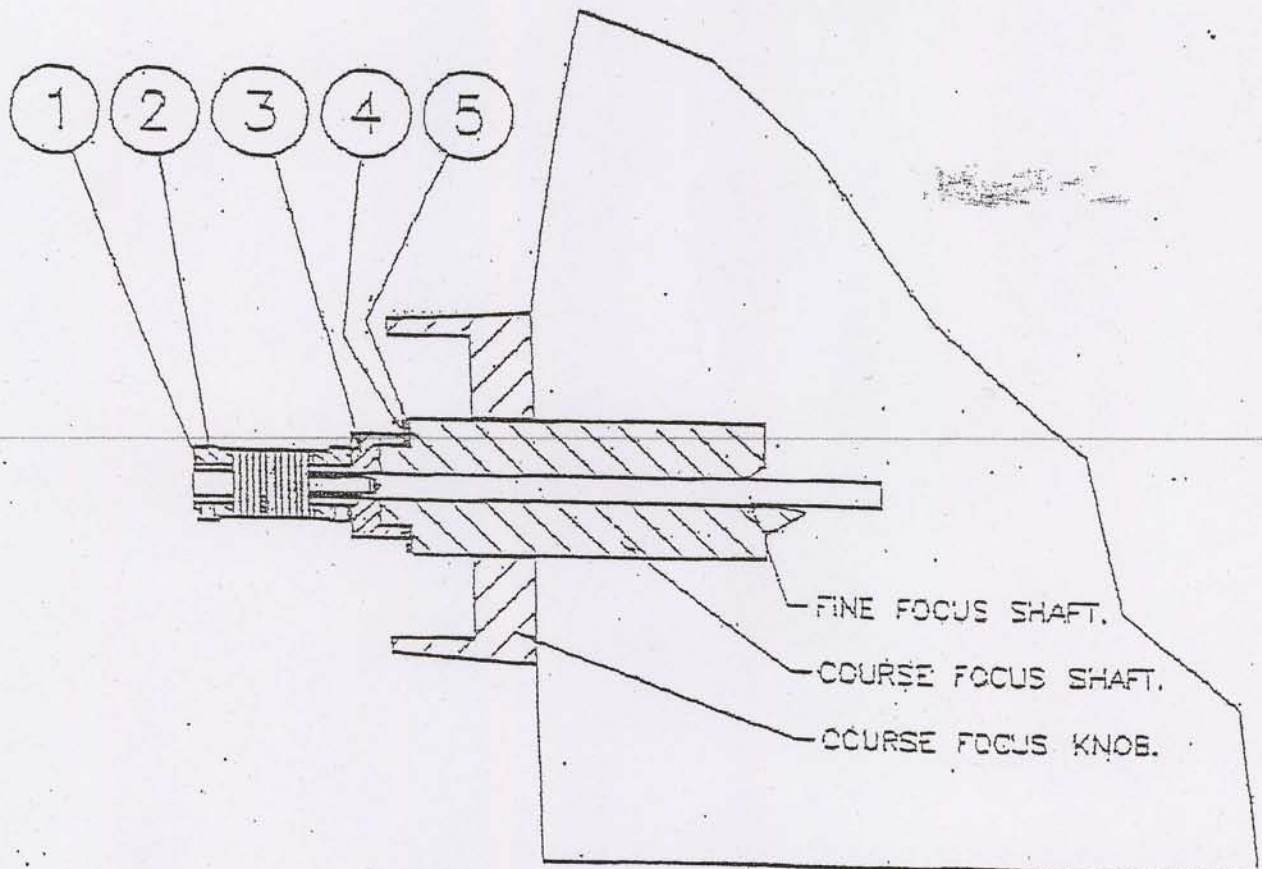

### STEP 2 (COUPLING TO FINE FOCUS SHAFT)

1. ENSURE BORE REDUCER (ITEM 1) IS IN ONE END OF COUPLING (ITEM 2).
2. PUSH COLLAR (ITEM 3) INTO THE OTHER END OF THE COUPLING.
3. ENSURE THE WASHER (ITEM 5) & THE SPRING WASHER (ITEM 4) ARE PLACED OVER THE COURSE FOCUS SHAFT. THEY SHOULD NOW BE IN THE SAME POSITION AS THEY WERE IN STEP 1.
4. PUSH THE COLLAR AND COUPLING OVER THE FINE FOCUS SHAFT. IT WILL BE NECESSARY TO APPLY PRESSURE TO THE OTHER END OF THE FINE FOCUS SHAFT. THIS WILL STOP THE SHAFT FROM MOVING AND SET THE CORRECT TENSION ON THE SPRING WASHER.
5. THE TWO SET SCREWS IN THE COLLAR END OF THE COUPLING CAN NOW BE TIGHTENED.



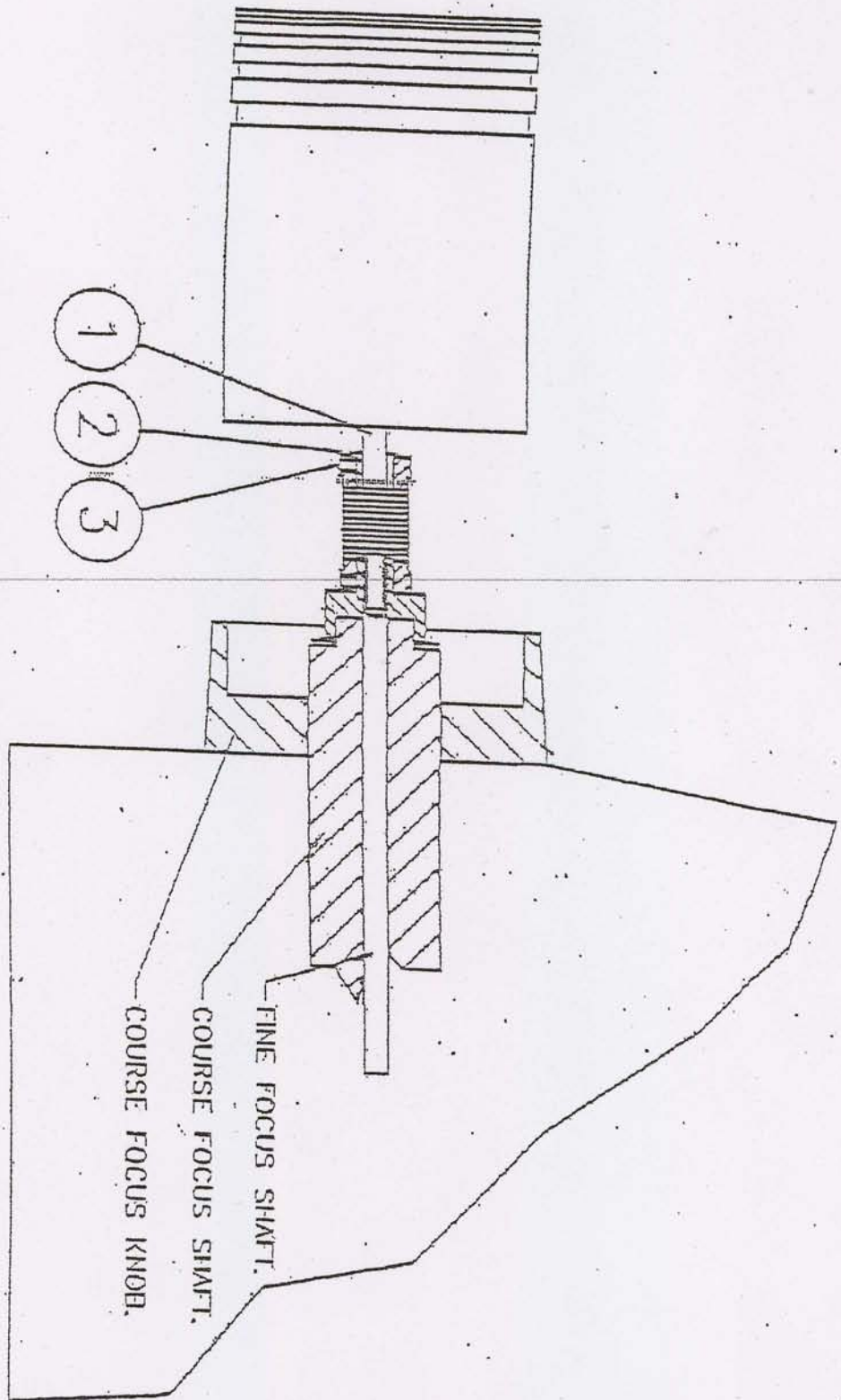

STEP 3 (MOTOR HOUSING TO COUPLING)

- 1. PLACE MOTOR (ITEM 1) SHAFT INTO COUPLING (ITEM 2)
- 2. TIGHTEN GRUB SCREW (ITEM 3).

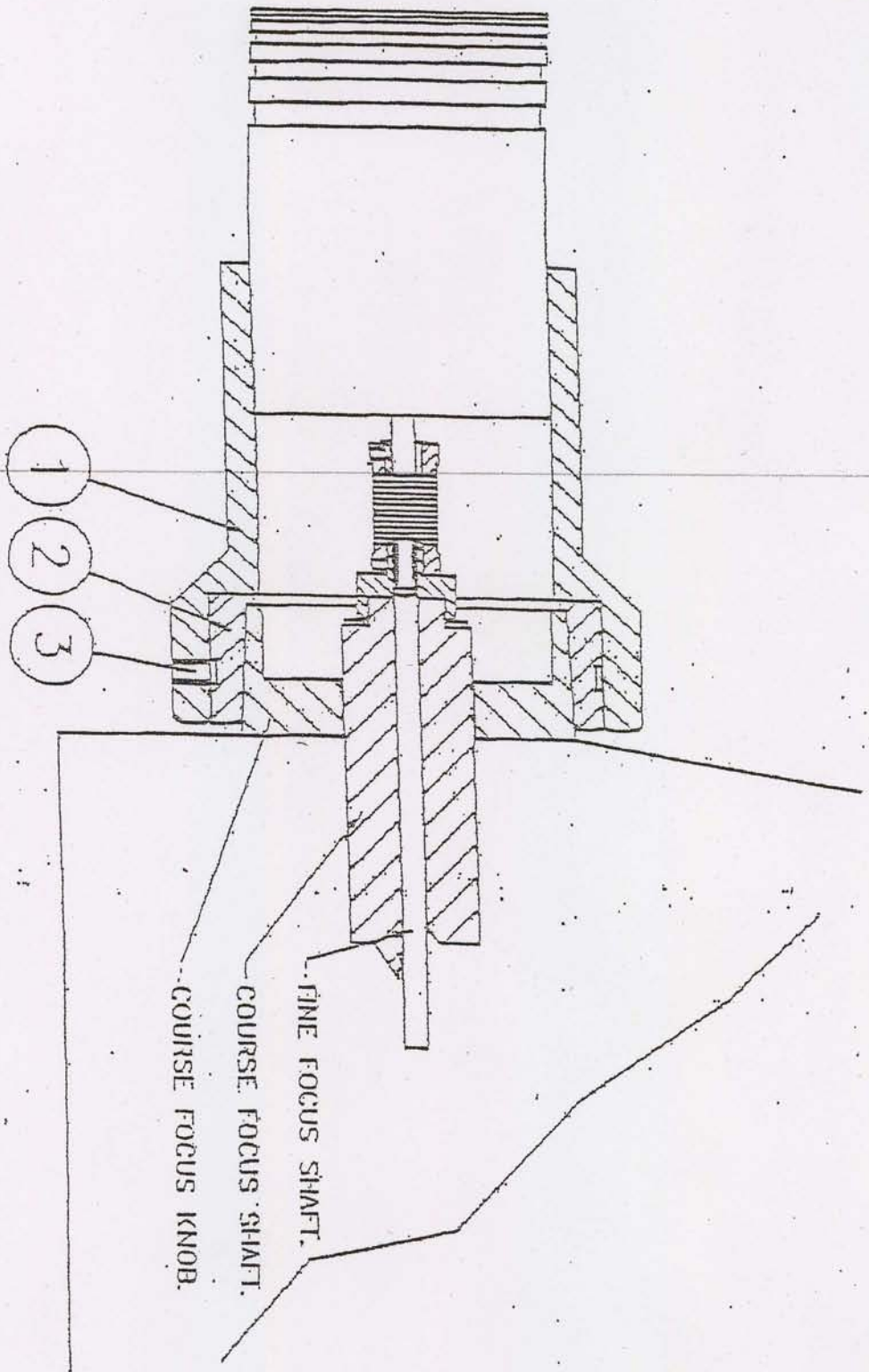

STEP 4 (MAIN BODY TO COURSE FOCUS KNOB)

1. PLACE MAIN BODY (ITEM 1) AND SLEEVE (ITEM 2) OVER THE MOTOR HOUSING AND COURSE FOCUS KNOB.
2. TIGHTEN THE THREE SET SCREWS (ITEM 3).

# Focus Drive Mounting Instructions for Leica DML Range - H122LB

Fitting the H122LB to the Leica DMLB involves removing the right hand fine focus knob. Note that this has two sensitivity settings depending on whether the fine focus mechanism is pushed to the right (4 microns) or pushed to the left (1 micron). This option is indicated by the label on the front surface of the left hand stabiliser.

The fine focus must be set at the 1 micron position.

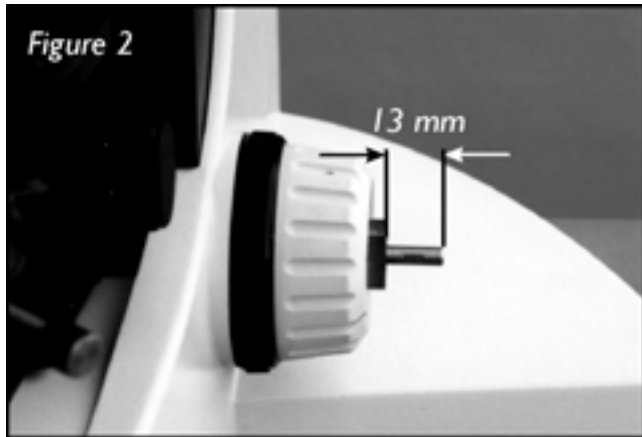

1. Push the fine focus fully to the left. Note the amount of the vernier scale showing on the left hand knob (figure 1). Fitting the H122LB is done with the fine focus in this 1 micron position.
2. Remove the right hand focus knob using the 1.5 mm hexagonal wrench key inserted down the small hole in the right hand fine focus. Hold the left hand fine focus knob when pulling off the right hand fine focus knob ensuring that there is no lateral movement of the shaft. There should be approximately 13mm shaft length

protruding from the brass boss (figure 2). Ensure that the small spring washer is still on the shaft.

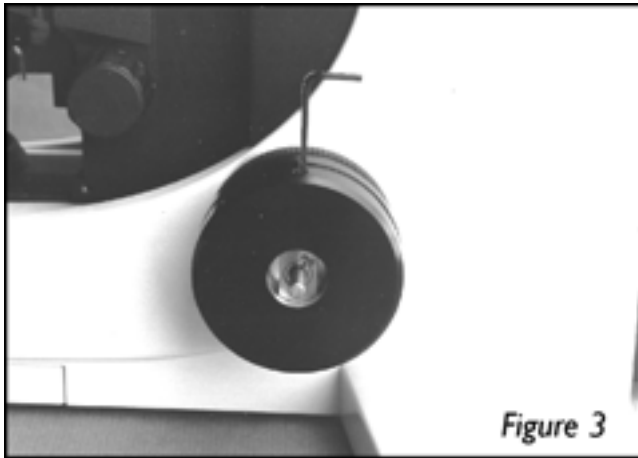

Figure 3

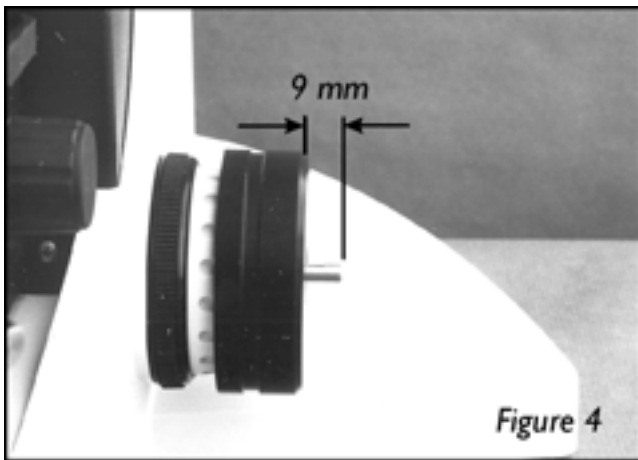

Figure 4

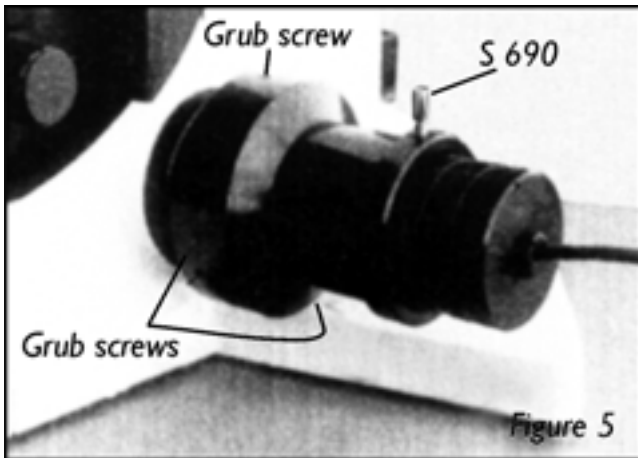

Figure 5

3. Fit the large adapter ring over the brass boss. Note that the orientation of the adapter ring should be such that the grub screw in the adapter ring screws down onto the centre of the radius (curved part of the brass boss) - (figure 3)

4. Push this fully towards the body of the microscope leaving approximately 9mm of shaft protruding from the adapter ring whilst tightening up the adapter ring using the 2mm hexagonal wrench key (figure 4).

5. Fit the drive coupling on the fine focus shaft using the 1.5mm hexagonal wrench key. Orient the shaft so that the grub screw will locate on the flat of the shaft. Push the drive coupling gently towards the adapter ring whilst tightening the grub screw.

Check that the fine focus rotates freely and is still set at 1 micron.

6. Fit H569 motor sleeve on the adapter ring. Tighten up 3 grub screws in sequence using the 2mm Hexagonal wrench key (figure 5). It may be

necessary to rotate the motor sleeve to gain access to each grub screw. The motor sleeve and adapter ring are now attached to the coarse focus.

Slide the H249 Microstep Focus motor assembly into the motor sleeve and tighten the S690 thumb screw whilst gently pushing the focus motor assembly towards the microscope such that there is a good contact between the rubber surfaces of the drive of the motor and the drive coupling (figure 5). The fitting is now complete.



# Focus Drive Mounting Instructions for Leica and DML and DMR Range – H122KLC

## *Notice:*

This installation should only be attempted by a qualified technician. It involves some minor disassembly of critical mechanical components. If you are not familiar with this type of mechanical assembly do not attempt this installation, consult your local microscope representative.

## *Components*

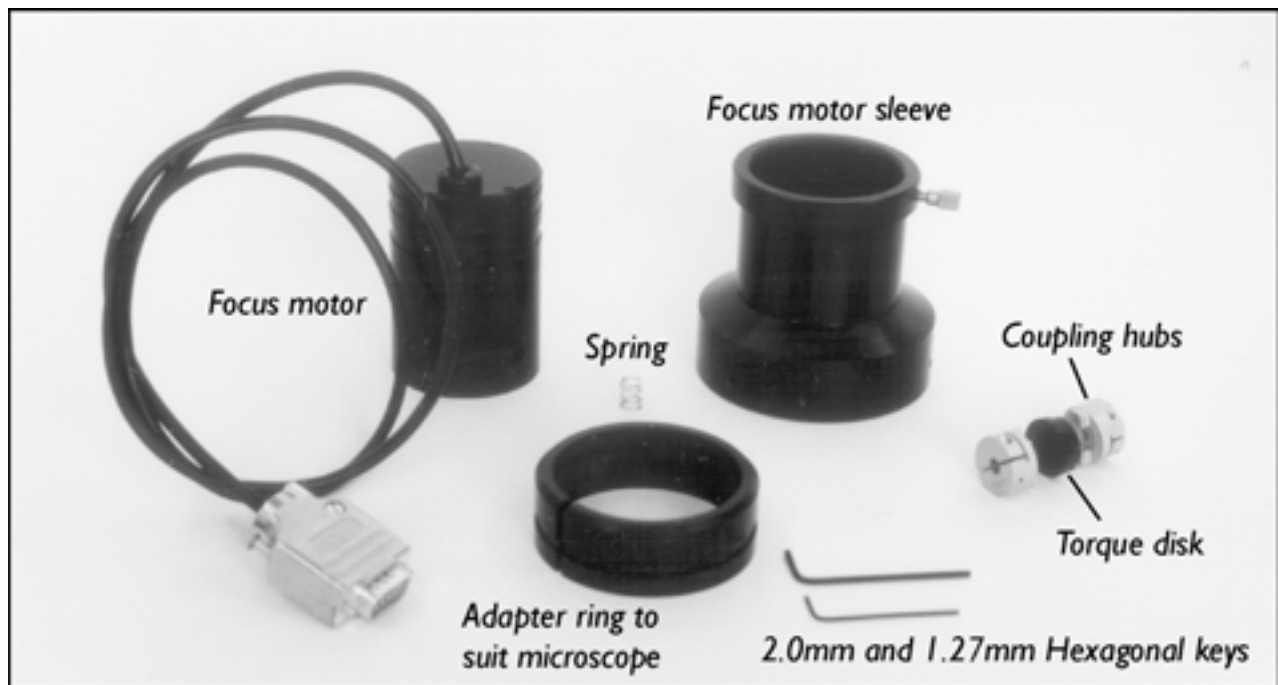

## **Installation on 'DMR'**

### *Step 1*

Using a 1.27mm Hexagonal key undo the fine focus set screw. The knob can then be pulled off.



### *Step 2*



Place the spring over the fine focus shaft and place a coupling hub on the shaft whilst holding the opposite focus knob in position, or it may disengage from gears.

Compress the spring by 3-6mm and clamp the hub using the 2mm hexagon key.

**Note:** Only one of the coupling hubs will fit the fine focus shaft.

### *Step 3*



Push the remaining coupling hub and plastic torque disc together and place on the focus motor shaft.

Tighten using the 2mm hexagon key making sure it does not bind on the motor casing.

### *Step 4*

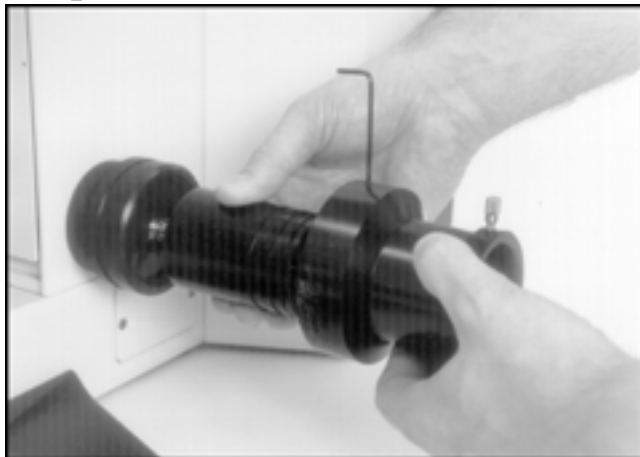

Place the adaptor ring over the coarse focus knob. Align and push the couplings together and slide the focus sleeve over the focus motor and onto the adaptor ring, using the 2mm hexagon key to tighten the three set screws. Again whilst holding the opposite focus knob.

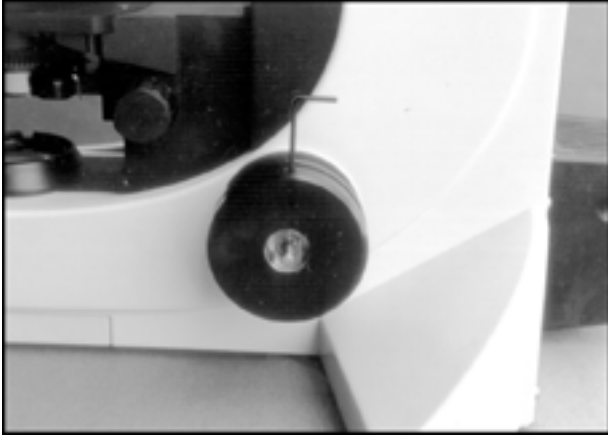

Step 1 as for 'DMR' series - then place the adaptor ring over the coarse focus knob and secure the brass shaft using the 2mm hexagon key on the set screw.

**Continue with steps 2, 3 and 4 as for 'DMR' series**

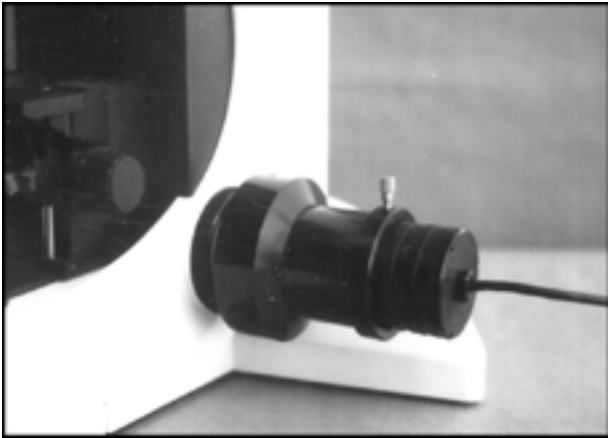

## **Instructions for mounting Prior Scientific Inc. Model 500-H122LMZ**

The following directions are for mounting Prior's 500-H122LMZ focus motor to the Leica MZ stereo focus block.

Tools required:

Flat screwdriver  
Metric Allen Keys

1. Remove screw at the end of the fine focus knob. Pull fine focus knob off of microscope. Figure 1



Figure 1

2. Using flat screwdriver remove 3 screws holding coarse focus knob to microscope. Remove coarse knob. Figure 2



Figure 2



3. Mount hub with 8mm ID to focus shaft, figure 3

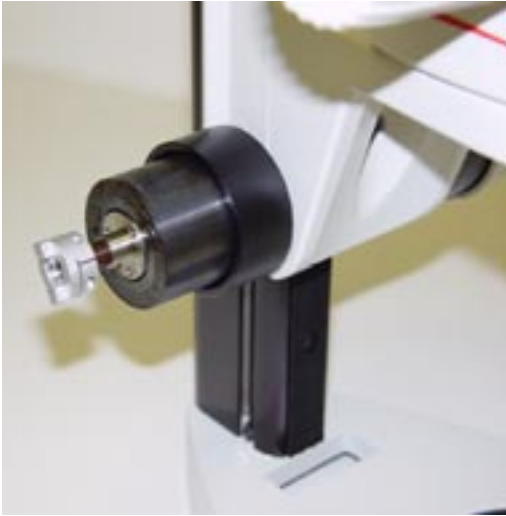

Figure 3

4. Install the focus motor housing and sleeve onto the smaller diameter of the focus mechanism, per the following instructions.

A. Loosen the thumb screw on the focus motor assembly and remove the focus motor from the focus adapter.

B. Loosen the 3 socket set screws around the periphery of the focus adapter using a 2mm Allen wrench until the focus sleeve is able to fit inside the adapter. Note that it is important to insert the sleeve in the correct orientation with the lip furthest inside the adapter (the chamfered edge of the sleeve will be inserted first). Note the orientation of the sleeve as it has a recess around its outer surface, which will hold the sleeve in when the setscrews are tightened. Note: The focus sleeve may already be installed into the focus adapter before shipping.

C. With the sleeve in place, tighten the 3 socket set screws in sequence until they all **just touch** the sleeve, ensuring that the split in the sleeve does not line up with any of the set screw positions. **DO NOT TIGHTEN UP ANY OF THE SETSCREWS AT THIS TIME.**

D. Push the adapter onto the smaller diameter of the focus mechanism of the microscope as far as it will go (this may be on the right or left depending on user preference). The inside/fitting diameter of the sleeve is designed to be slightly larger than focus mechanism, provided the setscrews have not been tightened and are compressing the sleeve.

E. While holding the adapter in place, tighten the set screws in sequence until the focus adapter is held securely in place. See figure 4



Figure 4

5. Line up the hub and black coupling on the focus motor with the hub installed on the focus shaft, figure 5



Figure 5

6. Slide the focus motor into the adapter as far as it will go. You may need to rotate the motor slightly to ensure the coupler seats itself correctly. While applying gentle pressure to the motor tighten the thumb screw, this will hold the motor in place. The coupler should now be engaged. This can be confirmed by manually rotating the exposed fine focus knob on the opposite side of the microscope and feeling for the resistance caused by the detent positions of the stepper motor as it rotates. Figure 6



Figure 6

7. Confirm that the controller is switched off before connecting the 9 way D type plug on the focus motor lead to the socket on the rear of the controller. The final assembly should look as below. Figure 7

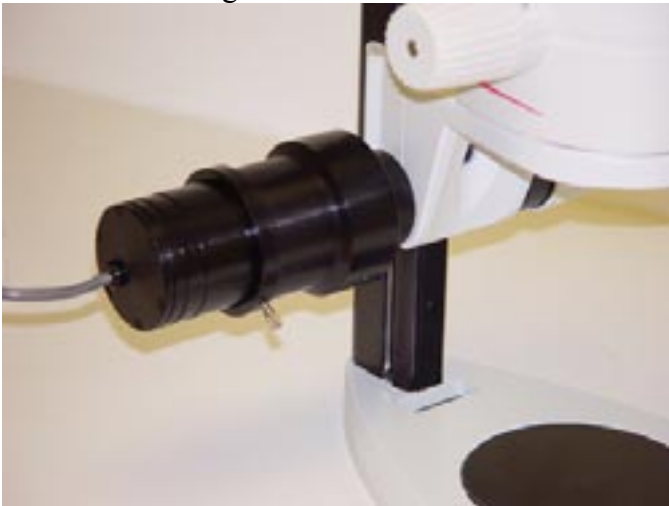

Figure 7

End of Instructions: Last revised 14 November 2002:JH

## Focus Drive Mounting Instructions for H122N onto Nikon E600

1. Remove large fine focus knob by removing two small Phillips screws.



2. Remove split ring from back of focus. To access these three screws, first remove hex screws from the front cover of the focus housing. Slip the split ring pieces over the microscope torque knob and tighten. Remember to align the three mounting screws with the three screws from the main focus housing.







3. Place the housing onto the split ring assembly and secure with the three screws. Then put the brass gear onto the focus shaft and secure with the two small screws provided.



4. Place the cover onto the focus housing and secure with the hex screws. The lever should then engage and disengage the fine focus mechanism.

# Focus Drive Mounting Instructions for H122S15 onto Nikon SMZ1500

## Installation Instructions

1. Remove the fine focus knob from the right side of the focus block with the 1.5mm hex key as shown



2. Remove the coarse knob with the Phillips screwdriver.

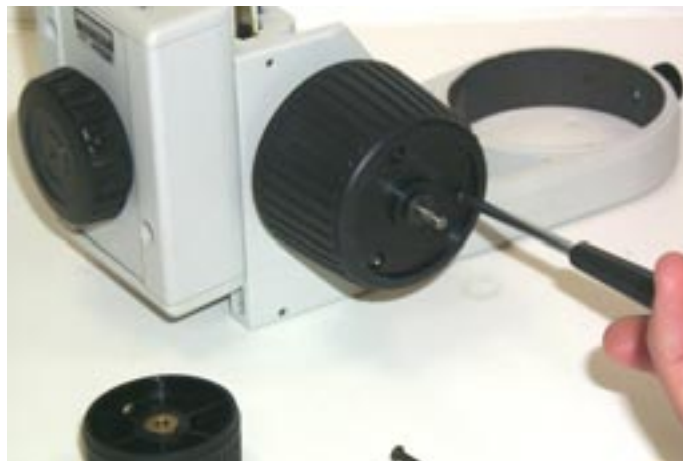

3. Remove the focus sleeve from the focus adapter by loosening the three set screws with the 2mm hex key.



4. Place the focus sleeve onto the focus block and make sure that it is pushed all of the way into the focus block.

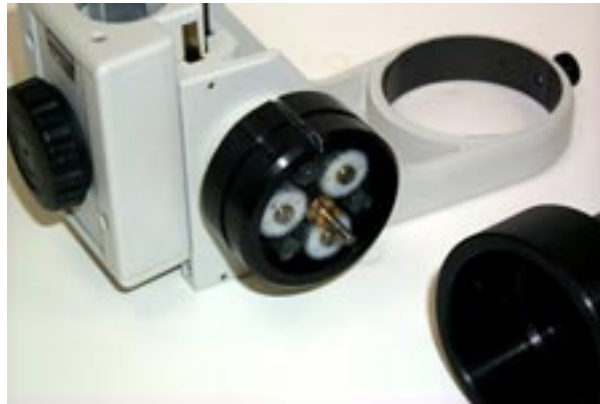

5. Place the silver coupler onto the focus shaft making sure that it does not extend beyond the hole in the coupler. This coupler is either loose in the bag with the focus motor or it is loosely attached to the focus motor shaft via a black anti-backlash coupling. (Note the other coupler attached to the focus motor shaft should not be removed.) Tighten the coupler onto the shaft using the 2mm hex key.



6. Remove the focus motor from the focus adapter by loosening the single set screw . Place the focus adapter over the focus sleeve and tighten the 3 set screws with the 2mm hex key. Slide the motor in, rotating it slowly to make sure that the two mating parts of the coupler interlock. Lock in the motor by tightening the motor lock screw.



**Special Notes:**

The speed limitation of the H122S15 is dependant upon the amount of weight carried by the focus block. The speed settings for the joystick/digipot and for RS232 movements may need to be decreased if the focus motor is determined to be stalling. Methods for decreasing these speeds are outlined in your manual.



# TE2000 INSTRUCTIONS



Loosen the 2 screws holding the fine focus knob to the microscope and remove the fine focus knob. It should look as shown in the photo on the left.

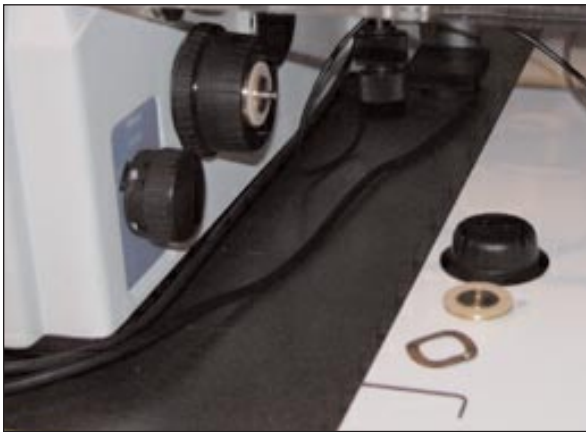

Remove brass end piece with plastic washer attached and remove wavy washer.

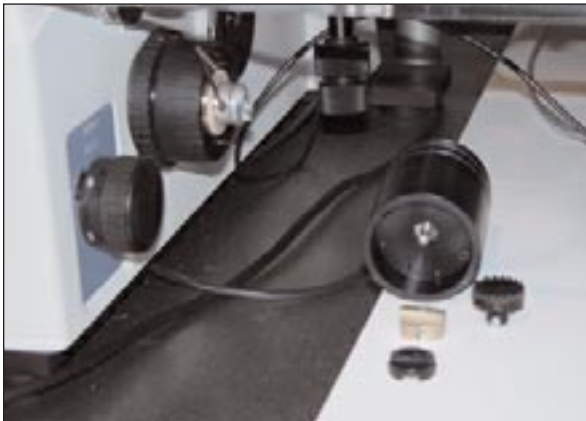

While holding the opposite side focus knob assembly, being careful not to push the fine focus shaft through the microscope body, slide the plastic washer provided as far onto the shaft as possible. Slide the M4 clamping hub onto the fine focus shaft up to the plastic washer. The hub should be pushed far enough onto the shaft so that when tightened the fine focus shaft has no lateral movement. Tighten the clamping hub.

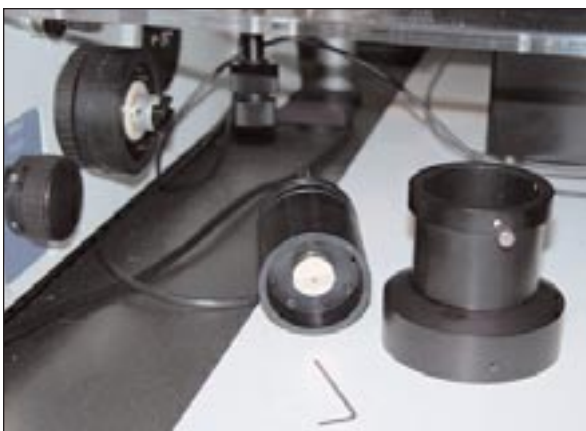

Install the black plastic coupler onto the clamping hub.

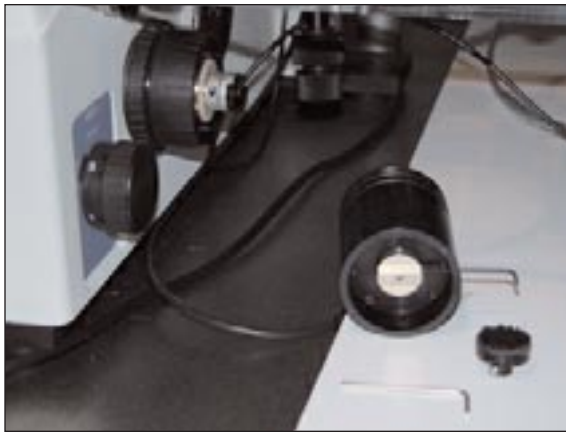

Remove the rubber friction coupler from the focus motor shaft and install the other M4 hub in its place

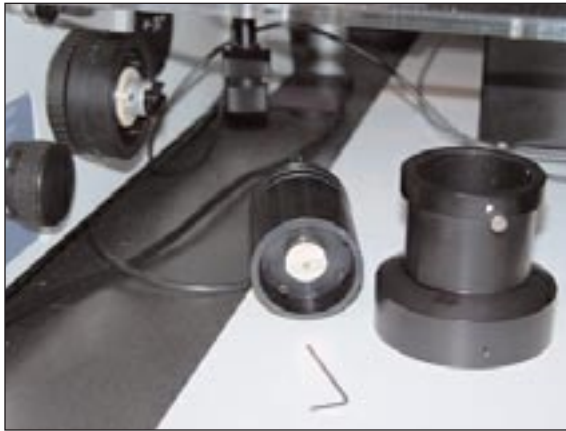

Place the focus motor adapter sleeve onto the coarse knob

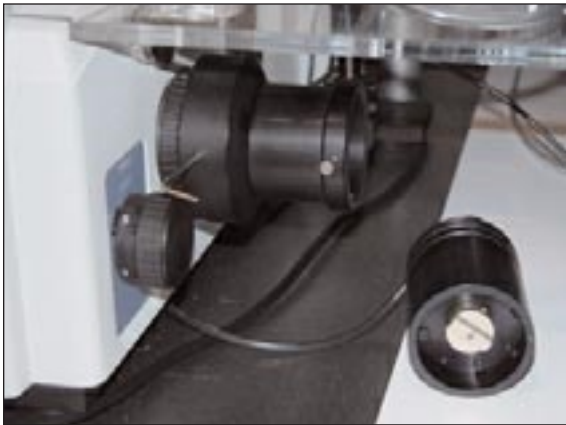

Slide the bell housing over the focus sleeve and tighten the 3 set screws around the periphery until the bell housing is secure.

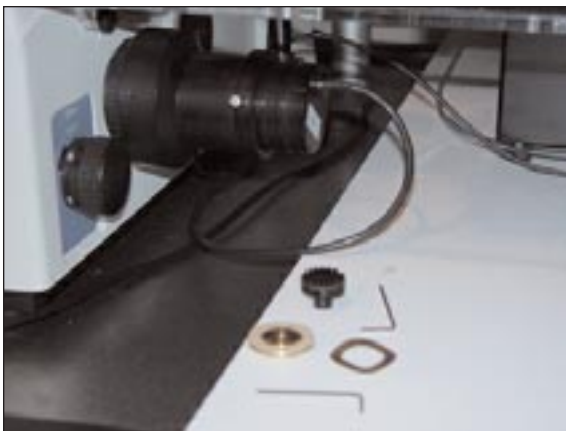

Slide the focus motor into the bell housing aligning the hub on the focus motor shaft with the black plastic coupler on the fine focus shaft. You may need to rotate the motor slightly to ensure they are properly engaged. Gently push against the motor and tighten the thumb screw holding the motor in place. The installation is now complete.

## Focus Drive Mounting Instructions for H122SZX – Olympus SZX



1. Remove screw holding focus knob assembly.

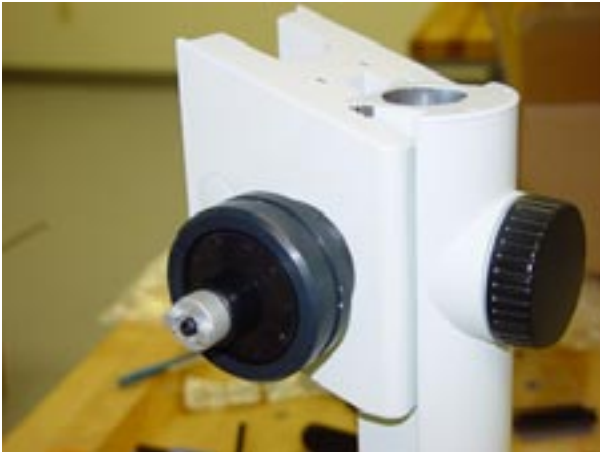

2. Attach hub to assembly using longer screw and washer provided with focus motor assembly. Take care to make sure the hub and fine focus knob are concentric.



3. Slide the split ring sleeve over the coarse knob. The chamfered end of the sleeve should be outward from the body of the microscope.



4. Slide the focus motor bell housing over the sleeve. Tighten the 3 set screws on the outer diameter of the bell housing. This will clamp the housing to the coarse knob outer diameter



5. Mount the 5mm hub and black anti backlash coupler to the end of the focus motor. The hub will tighten to the motor shaft via the set screw on its side.





6. Slide the focus motor into the bell housing. While applying gentle pressure inward on the motor, tighten the thumb screw. Note you may have to rotate the motor in order to seat the coupling correctly.

# Focus Drive Mounting Instructions for H122X200 Zeiss Axiovert 200

## Tools required

2 mm Hex. Wrench  
3 mm Hex. Wrench  
Medium Flat Blade Screwdriver

## Fitting Instructions

If a stage is fitted to the microscope it will be necessary to remove it before installation.

- 1) Firstly attach the probe reference bracket to the microscope objective holder mount with the two M3 x 10 screws provided (see fig.1).



Fig. 1

- 2) Using a flat blade screw driver attach the frame mounting bracket assembly as shown in fig.2



- 3) If necessary adjust the triangular end block by loosening it's mounting screw and rotating, so that the encoder mounting shaft will be as perpendicular as possible when fitted (fig. 3).



- 4) Fit encoder mounting shaft and encoder as shown in fig. 4 ensuring that the probe is positioned centrally on the glass reference disc (fig. 5)



Fig. 4

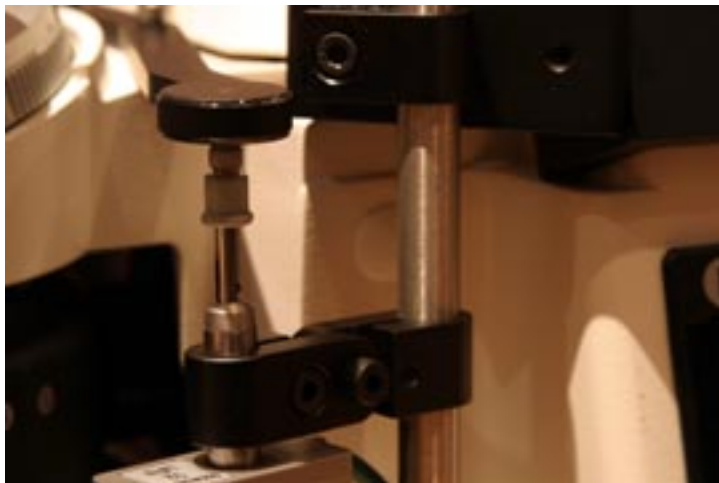

Fig.5

- 5) **It is most important that the focus motor assembly is fitted to the right hand side of the microscope only.** Before attaching the focus motor, the rubber cover which is normally fitted over the fine focus knob will need to be removed as shown in fig. 6



Fig. 6

- 6) Place the two halves of the focus adapter sleeve over the coarse control knob as shown in fig. 7

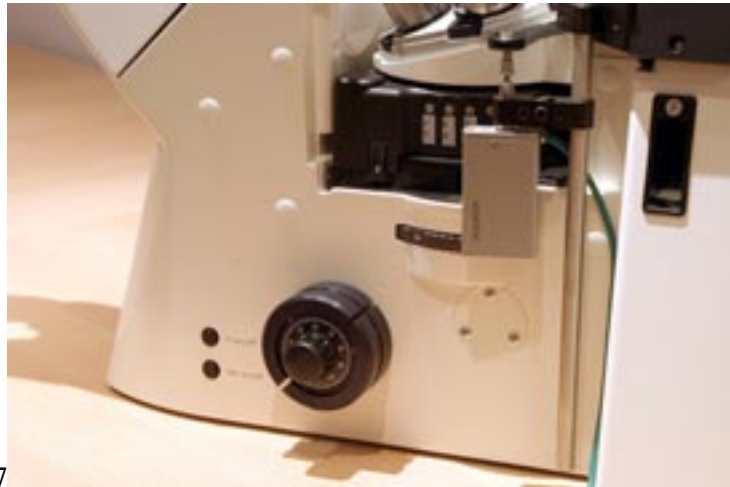

Fig. 7

- 7) While holding both halves of the focus adapter sleeve in place, slide the outer housing of the focus motor assembly over them as far as it will go. Tighten the three setscrews that are positioned around the periphery of the outer housing until secure, ensuring that they line up with the recess that runs around the outer surface of the sleeve. Care should be taken not to over tighten or position any of the screws over the gaps between the two halves of the adapter sleeve. Check that the unit has been tightened sufficiently by taking hold of it and turning it, if the adapter is correctly fitted it will stay attached.

- 8) Slide the focus motor into the outer housing as far as it will go and while applying gentle pressure to the motor tighten the clamp screw as shown in fig. 8. This will hold the motor in place. The rubber drive bush on the end of the motor spindle should now be pressing against the end surface of the fine focus knob. This can be confirmed by manually rotating the exposed fine knob on the opposite side of the microscope and feeling the resistance caused by the detent positions of the stepper motor as it rotates. This will not cause any damage to the focus motor.



Fig. 8

- 9) Confirm that the controller is switched off before connecting the digipot (if supplied), focus motor and encoder cables to the relevant sockets on the rear of the controller.
- 10) Re-fit stage.
- 11) Installation is now complete.



# Focus Drive Mounting Instructions for Non Standard Focus Drive Installations

## *Notice:*

This installation should only be attempted by a qualified technician. It involves some minor disassembly of critical mechanical components. If you are not familiar with this type of mechanical assembly do not attempt this installation, consult your local microscope representative.

## *Introduction*

The focus drive is compatible with all of the Zeiss Axio type microscopes listed below. However, it is not compatible with the Zeiss Axioskop 2 and Axioplan 2. The focus drive must be attached to the fine focus ball reduction mechanism as follows:

Axioplan .....Left Side .....Right side	Axiotron 10.....Right side	Axiolab
Axioskop.....Left Side .....Right side	Axiovert 35 .....Right side	Standard
Axiovert 25 .....Left Side .....Right side	Axiovert 100 .....Right side	Axiovert 135

## *Components*

The focus drive assembly is comprised of the following:

- Drive motor, motor bracket and switch assembly
- Mounting block
- Anti backlash gear and locknut
- Cover and lead

Also included are screws and hexagon keys needed to install the focus drive unit.

## *Tools Required*

14mm AF spanner or socket, 1pt Philips screw driver, 1.27mm hexagon key (supplied)  
2.5mm hexagon key (supplied) 3.0mm hexagon key (supplied).



### *Prepare the focus drive*

- Remove the cover.
- Remove bag containing anti-backlash gear, locknut and hexagon keys.
- Using 3.0 hexagon key remove the two 4mm cap head screws that hold the mounting block to the motor bracket assembly.

### *Installation of the focus drive*

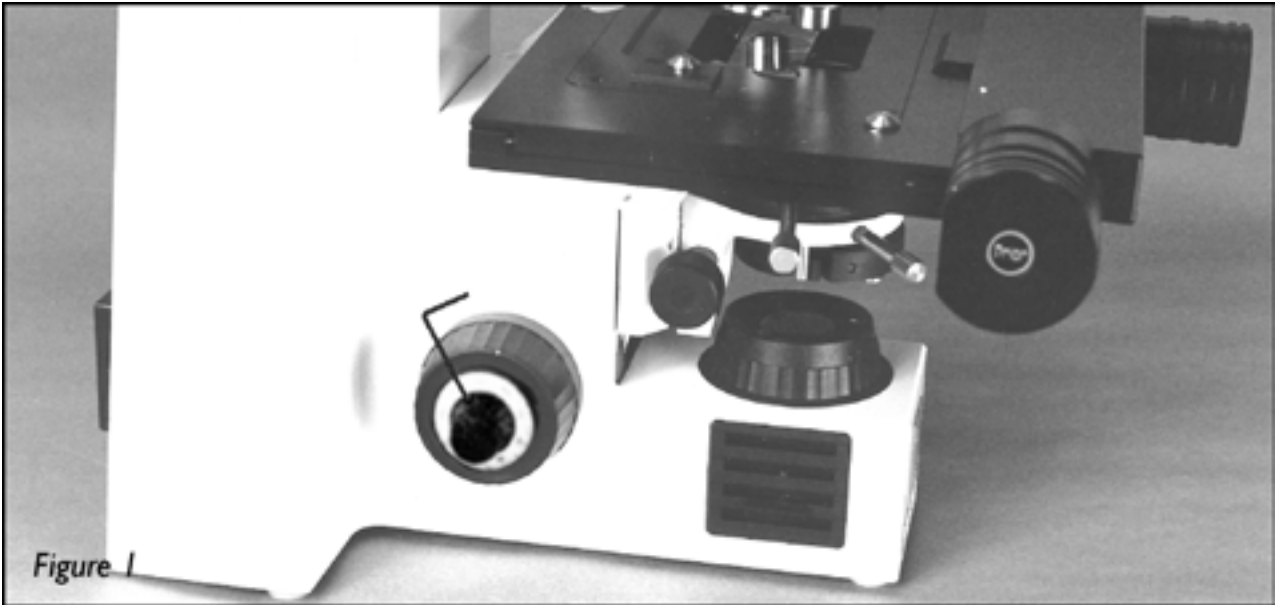

1. Determine which side the focus drive must go (see introduction).  
Remove the fine focus knob by using the 1.27mm hexagon key to unscrew the set screw. The knob can then be pulled off.

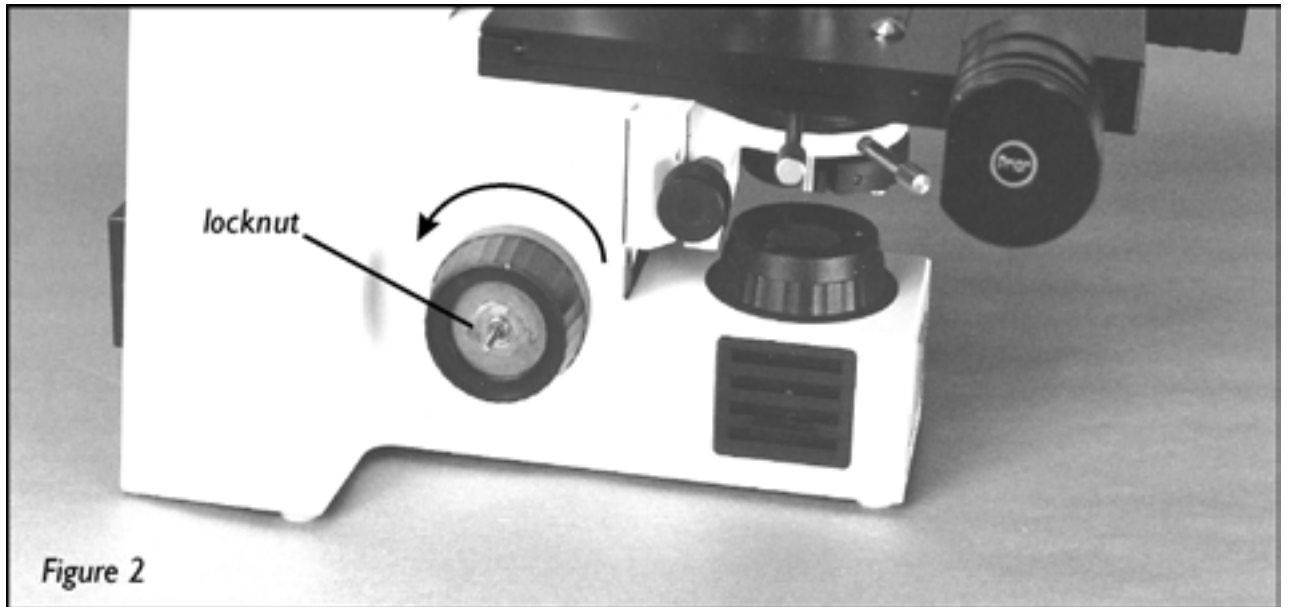

2. Using the 14mm spanner or socket to remove the lock nut. The coarse knob can now be removed by turning anti-clockwise and unscrewing from the coarse focus shaft.
3. A black plastic cover should now be visible (see fig. 3). If this is not the case, check the introduction to ensure you removed the knobs from the correct side. **It is very important that you replace both coarse and fine knobs before removing the knobs on the opposite side.**

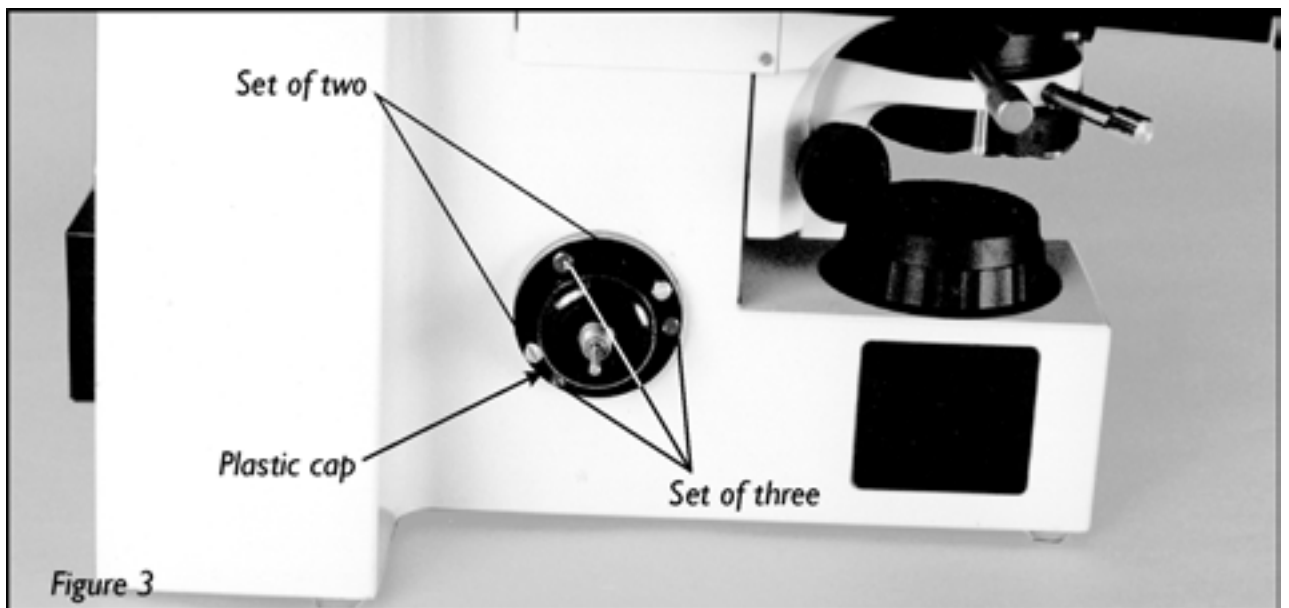

The plastic cap is held on with five screws, one set of two screws and one set of three. If the set of two screws are missing then install the two M3 x 6mm cap head screws supplied. Remove the set of 3 screws using the 2.5mm hexagon key.

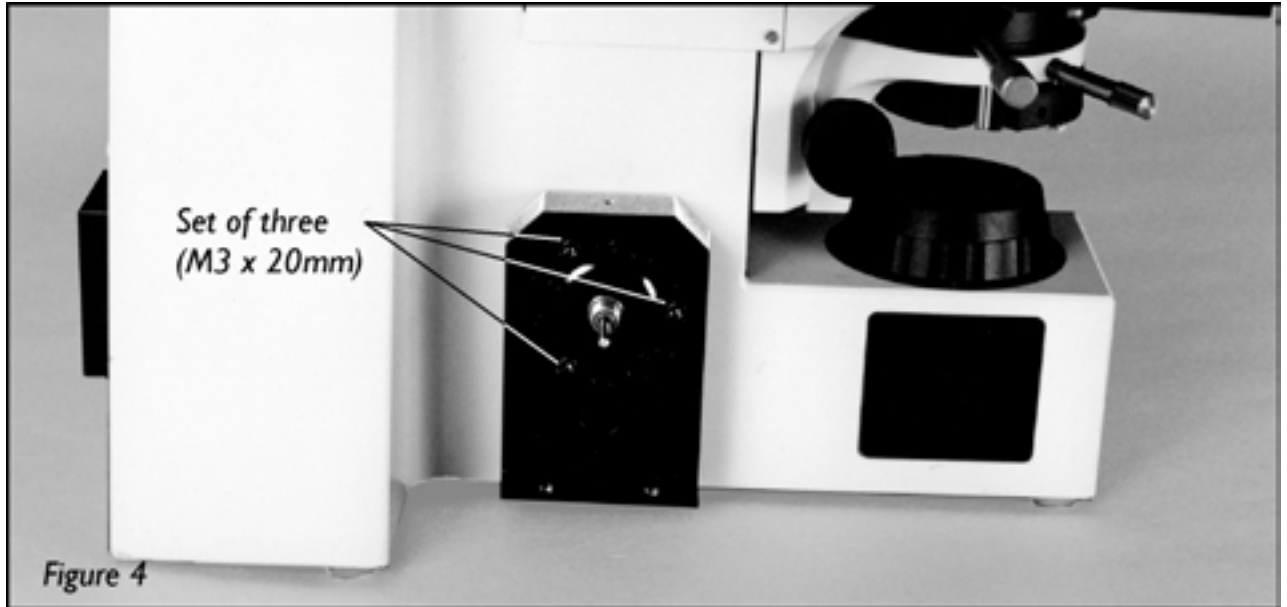

4. Place the mounting block over the plastic cap and hold in place using the 3 M3 x 20mm cap head screws supplied.

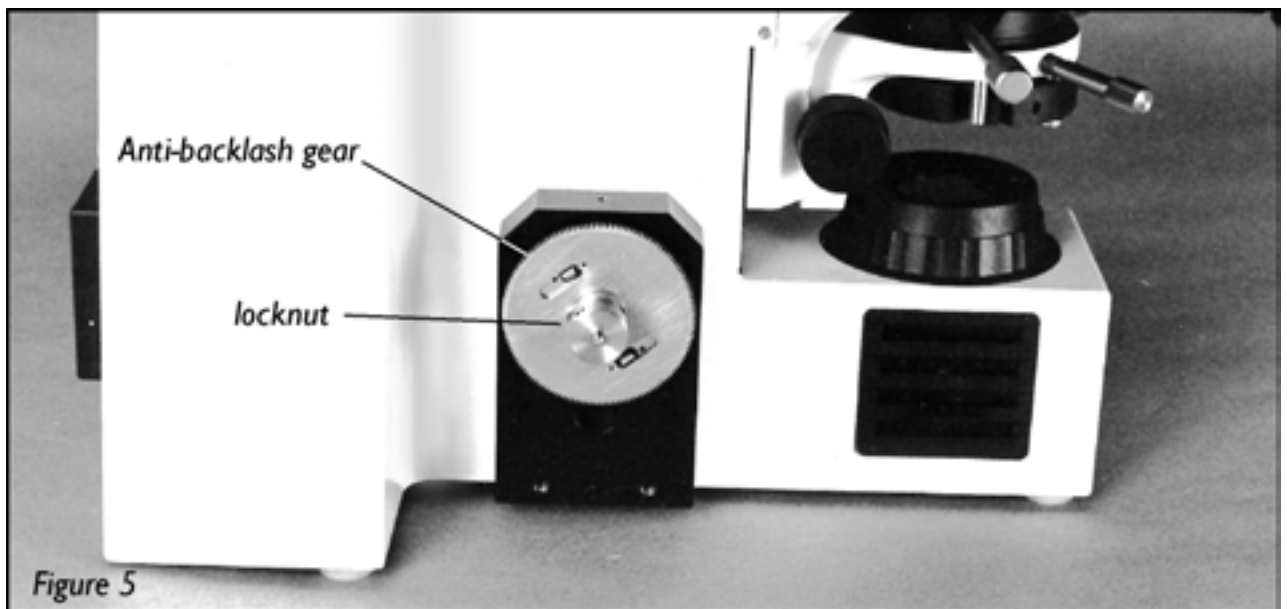

5. Screw the anti-backlash gear onto the coarse drive shaft, making sure the gear's boss is facing outwards. Screw the locknut into the boss and tighten.

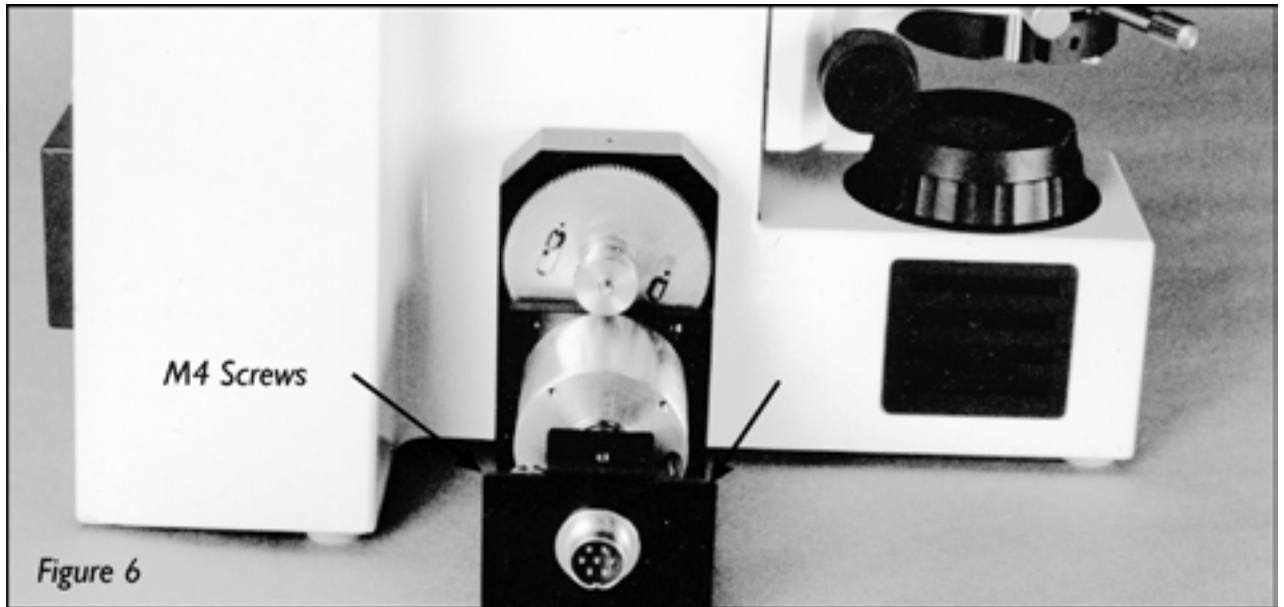

6. Attach the motor, bracket and switch assembly to the mounting block using the two M4 cap head screws. The anti-backlash gear has two gears, one fixed, the other spring loaded and free to rotate. Rotate this gear approximately 6 teeth before aligning with the motor gear.

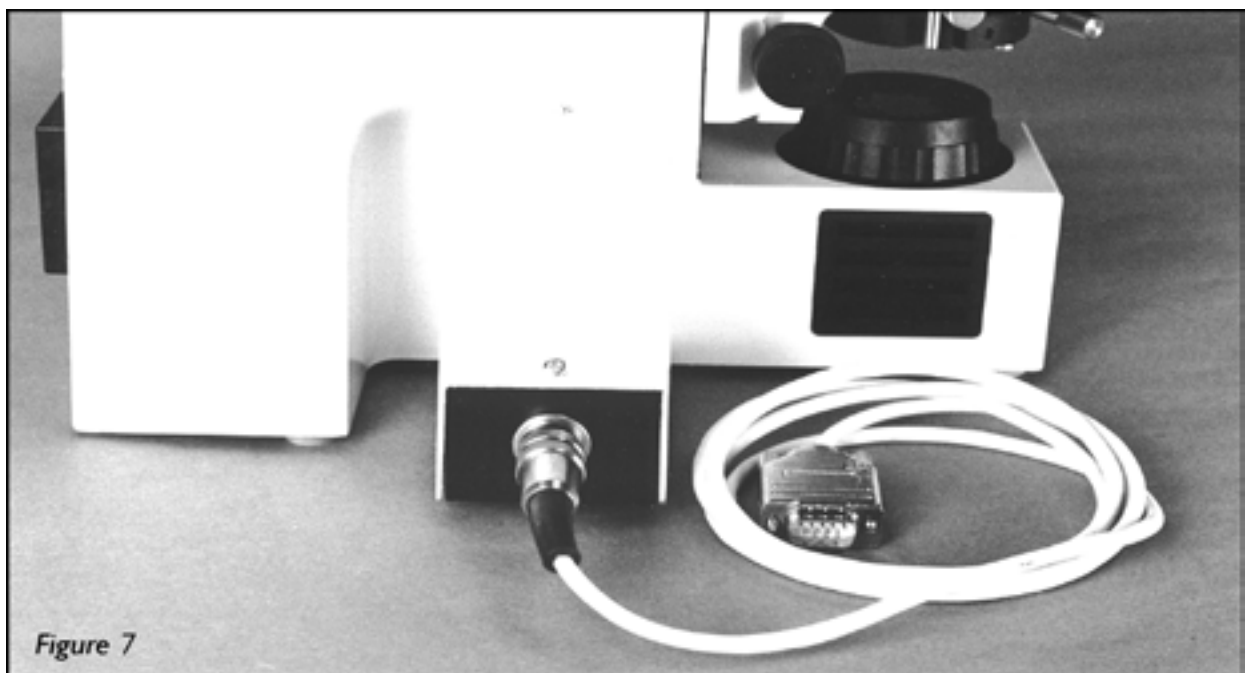

7. Replace the cover and attach the lead.

**If the focus drive unit appears to drive in the wrong direction, i.e. you ask the controller to move up and the stage moves down, then the switch is set to the wrong position. Disconnect the power supply to the focus drive, remove the cover, move the switch and then replace the cover. The unit will now move in the correct direction.**

## H122AXIE Zeiss Axio Series Encoded Focus Drive Installation Instructions

The H122AXIE focus drive is only compatible with the microscope models listed below and it is very important that it is attached to the correct side of the instrument.

Axioplan	Left side
Axioplan 2 *	Left side
Axioskop/Axioskop 20	Left side
Axiovert 35	Right side
Axiovert 100/S100/I35	Right side
Axiovert I35	Right side

\* Please note that the H122AXIE is not compatible with the Axioplan 2ie and Axioplan 2 Imaging models). For these instruments the H122X2 is required.

**Please note this installation should only be attempted by a qualified technician. It involves some minor disassembly of critical mechanical components. If you are not familiar with this type of mechanical assembly, we recommend that you do not attempt this installation and instead contact your local microscope dealer or Prior representative.**

### Tools required

1.3mm Hex. Wrench  
2.5mm Hex. Wrench  
3mm Hex. Wrench  
Medium Flat Blade Screwdriver  
1 pt Philips Screwdriver  
14mm AF Spanner or socket

### Fitting Instructions

- 1) Firstly determine on which side of the microscope the focus drive must be fitted (see above).
- 2) Remove the fine focus control knob using a 1.3mm hex. Wrench.
- 3) Using the 14mm spanner/socket undo the locknut holding the coarse control knob in position. The coarse knob can now be removed by turning anti-clockwise and unscrewing from the mounting shaft. A black plastic cover should now be visible (see fig.1). If this is not the case, check above to ensure that the knobs have been removed from the correct side. **It is very important that both the coarse and fine control knobs are replaced before removing knobs from the opposite side.**



**Figure 1**

- 4) Attach coarse focus shaft and tighten using a hex. wrench through the 2nd of the two clearance holes as shown in fig. 2.



**Figure 2**



- 5) Align the machined flat on the microscope fine focus shaft with the first hole in the coarse focus shaft. Push the extension shaft onto the microscope fine focus shaft and tighten the fixing screw as shown in figure 3.



**Figure 3**

- 6) It is now necessary to remove three of the five screws that hold the black plastic cap onto the microscope. Only remove the three screws, which are equally spaced, the remaining two are positioned directly opposite each other, these need to remain in position.
- 7) Remove the main cover from the H122AXIE assembly and attach the frame to the microscope using the three M3 x 20 socket cap screws provided. It will be necessary to remove the frame end plate and also the motor direction switch mounting bracket as shown in fig .4.



**Figure 4**

- 8) Push the rotary encoder assembly over the coarse shaft ensuring that the dowel pin is positioned into the locating slot on the encoder. Tighten the screw on the encoder clamping collar as shown in fig. 5

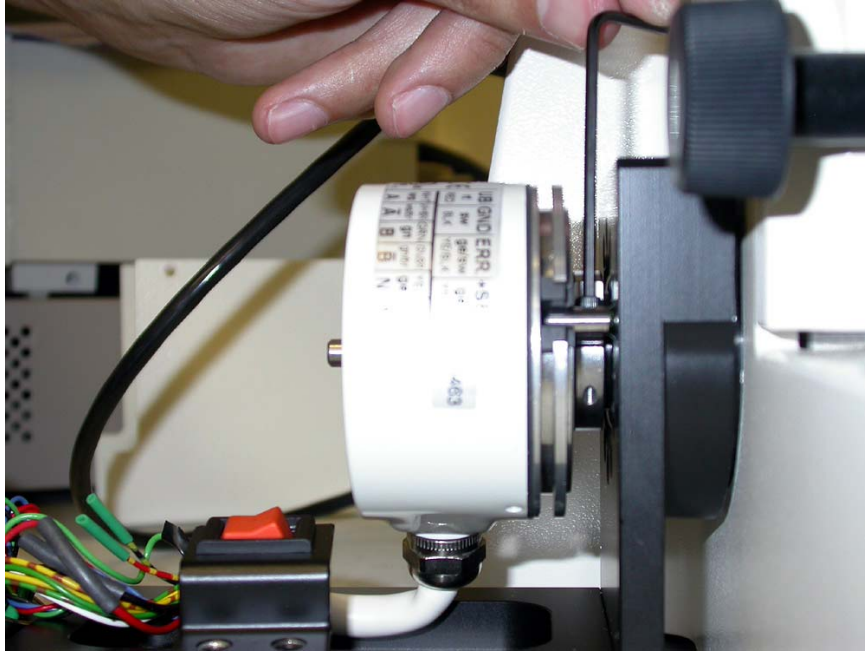

**Figure 5**

- 9) Attach the flexible coupling to the extension shaft, which should be protruding from the centre of the encoder. Re-assemble the switch mounting bracket and frame end plate so that the free end of the flexible coupling can be attached to the drive motor (see fig. 6).

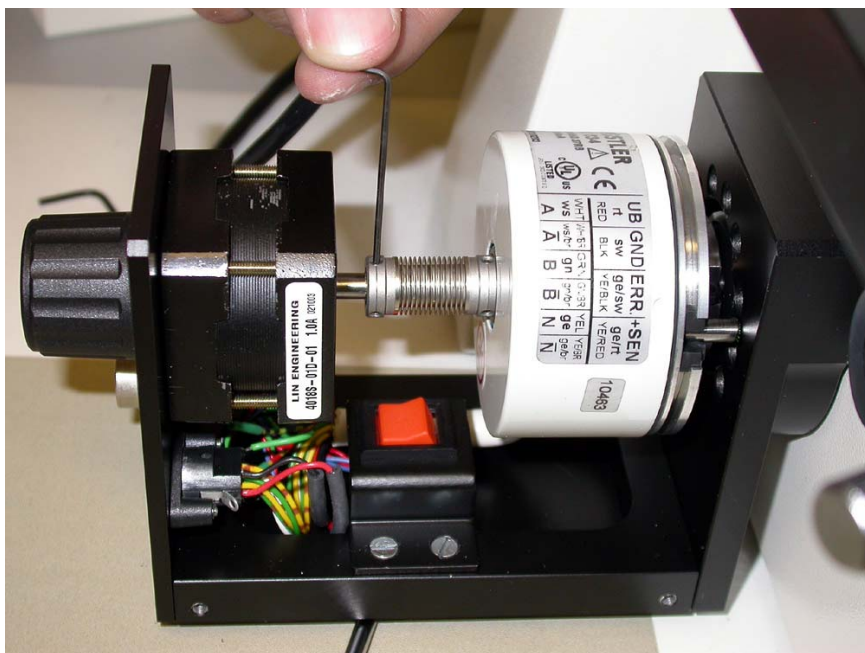

**Figure 6**

- 10) Re-fit the main cover and the installation is complete, Figure 7.

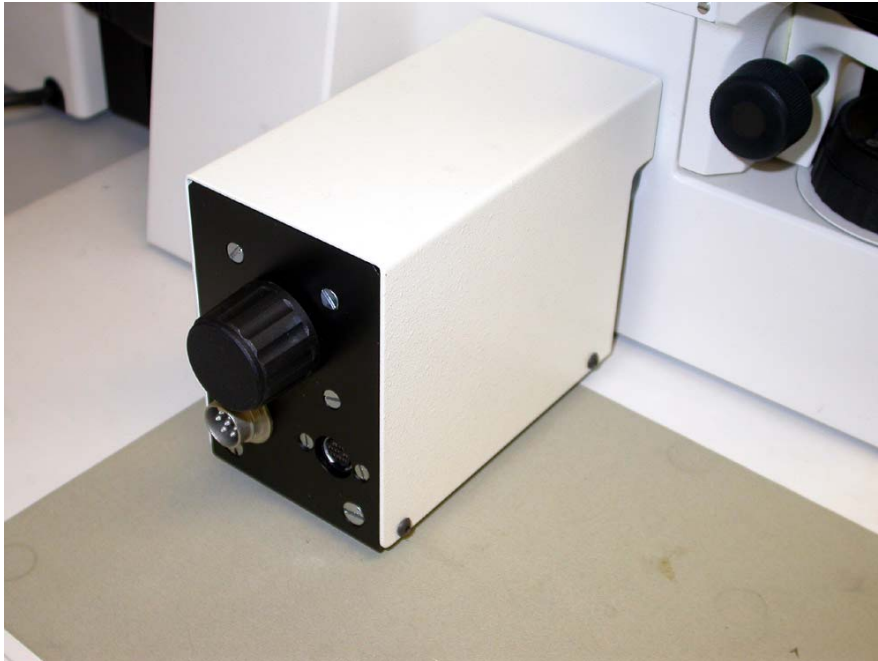

**Figure 7**

**Note**

If the focus drive appears to drive in the wrong direction, i.e. if you ask the controller to move up and the stage/objective carrier moves down, then the motor direction switch is set to the incorrect position. Simply disconnect the power supply, remove the cover and adjust the switch. Re-assemble and the unit will now drive in the opposite direction.