

Evident/Olympus SZX series configuration chart

6 Sample holders

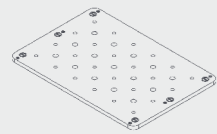

H230B
Breadboard insert plate

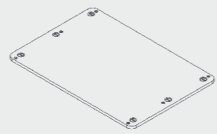

H230
Solid stage plate

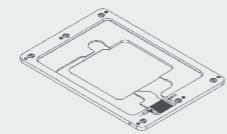

H224LP
Low profile 3 in x 1 in slide holder

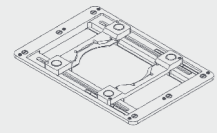

H473UP
Universal sample holder

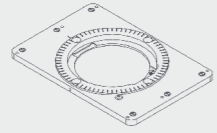

H224ROT
3 in x 1 in manual rotating slide holder

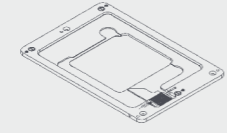

H237LP
Low profile 3 in x 1 in slide holder

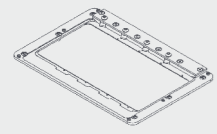

H234LP
Low profile, four 3 in x 1 in slide holder

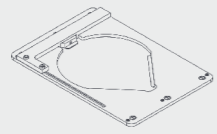

H229UP
Universal Petri dish holder



H3848
Low profile slide holder adapter kit

6 Sample holders

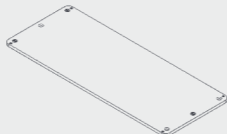

H239
Solid stage plate

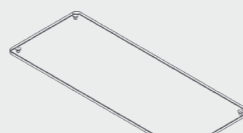

H288
Glass stage plate

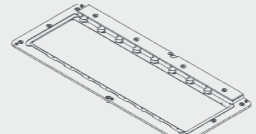

H238LP
Low profile eight 3 in x 1 in slide holder

1 Stages

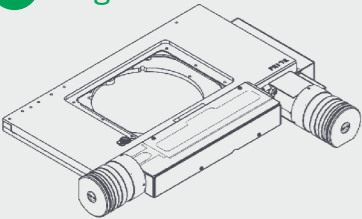

**H101BX, HE01BX,
H1P4BX, HEP4BX**
ProScan upright stage

1 Stages

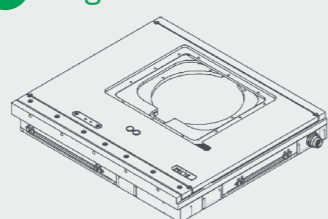

**H101P2BX, H101E2BX,
H101P1BX, H101E1BX**
ProScan upright stage, flat top

1 Stages

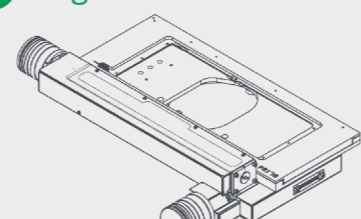

H138BX, HE38BX
ProScan upright stage, large format

6 Stage accessories



H230F
Solid stage plate

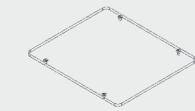

H220F
Glass stage plate

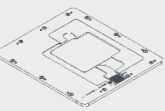

H224F
Low profile 3 in x 1 in slide holder

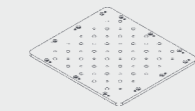

H230FB
Breadboard stage insert assembly

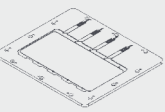

H234F
Four 3 in x 1 in slide holder

5 Motorized focus

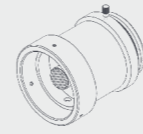

**PS3H122SZX
PS3H122SZX2**
ZX focus drive and adapter

7 Illumination

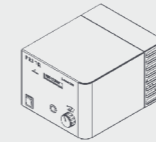

L200SOL, L220SOL
Fluorescence illuminator,
built in shutter

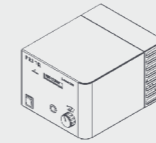

L200OL, L220OL
Fluorescence illuminator

2 Excitation path

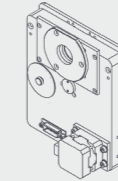

HF110A
Filter wheel, 10 position,
25 mm diameter filters



HF110A + HF200HT
10 position 25 mm diameter
filter wheel plus shutter
combination

HF110

Filter wheel, 10 position,
25 mm diameter filters with stand

HF108A + HF201HT
8 position 32 mm diameter
filter wheel plus shutter
combination

HF106A

Filter wheel, 6 position,
25 mm diameter filters

HF108A

Filter wheel, 8 position,
32 mm diameter filters

HF108

Filter wheel, 8 position,
32 mm diameter filters with stand



HF235
Filter wheel adapter

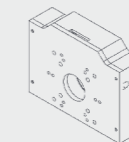

HF202HT
25mm high temperature
standalone shutter

HF204HT

35mm high temperature
standalone shutter

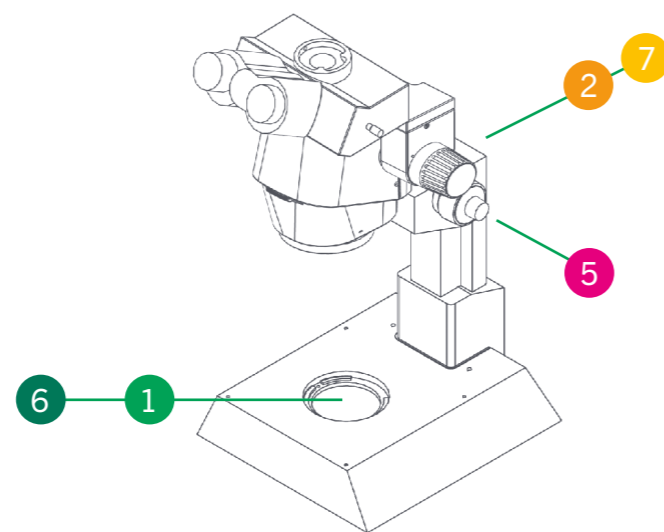

See the following pages for more product information.

Evident/Olympus SZX configuration guide

The Evident/Olympus SZX is an advanced stereo microscope. Prior are able to supply stages and illumination upgrades for this microscope.

Stages and sample holders

All the sample holders listed in the first section of the above table are compatible with the H101BX, HE01BX, H1P4BX, and HEP4BX. All the sample holders listed in the second section are compatible with the flat top H101P2BX, H101E2BX, H101P1BX and H101E1BX. In addition, sample holders from the first section are compatible with the flat top stage range when combined with the H3848. The large format H138BX and HE38BX can support up to 8 slides. All stages require the SZX-STAD2 adapter from Evident/Olympus to be fitted.

Motorized XY stages and sample holders

Part	Description
H101BX	ProScan upright stage, part encoded, 2 mm pitch, 200 step, Evident/Olympus BX
HE01BX	ProScan upright stage, encoded, 2 mm pitch, 200 step, Evident/Olympus BX
H1P4BX	ProScan upright stage, part encoded, 1 mm pitch, 400 step, Evident/Olympus BX
HEP4BX	ProScan upright stage, encoded, 1 mm pitch, 400 step, Evident/Olympus BX
H473UP	Universal sample holder (slides, Petri dishes, small flasks), upright
H224LP	Low profile 3 in x 1 in slide holder
H234LP	Low profile, four 3 in x 1 in slide holder
H237LP	Low profile 3 in x 2 in slide holder
H229UP	Universal Petri dish holder, upright stages, up to 90 mm diameter
H230	Solid stage plate, H101A stages
H224ROT	3 in x 1 in manual rotating slide holder
H230B	Breadboard insert plate M4 & M6 (H101)
H220	H101 glass stage plate assembly

Flat top XY motorized stages and sample holders

Part	Description
H101P2BX	ProScan upright stage, flat top, part encoded, 2 mm pitch, 200 step, Evident/Olympus BX
H101E2BX	ProScan upright stage, flat top, encoded, 2 mm pitch, 200 step, Evident/Olympus BX
H101P1BX	ProScan upright stage, flat top, 1 mm pitch, 200 step, Evident/Olympus BX
H101E1BX	ProScan upright stage, flat top, encoded, 1 mm pitch, 200 step, Evident/Olympus BX
H3848	Low profile slide holder adapter kit for H101F
H230F	Solid stage plate, H101F Stages
H224F	Low profile 3 in x 1 in slide holder, extended, H101F stages
H234F	Four 3 in x 1 in slide holder, H101F stages
H220F	Glass stage plate, H101F stages
H230FB	Breadboard stage insert assembly (H101F)

Large format XY motorized stages and sample holders

Part	Description
H138BX	ProScan upright stage, part encoded, 2 mm pitch, 200 step, Evident/Olympus BX, for up to 8 slides
HE38BX	ProScan upright stage, encoded, 2 mm pitch, 200 step, Evident/Olympus BX, for up to 8 slides
H238LP	Low profile eight 3 in x 1 in slide holder
H238PLP	Low profile eight 3 in x 1 in slide holder, part recessed
H239	Solid stage plate, H138 stages
H288	Glass stage plate, H138 stages

Motorized focus

Both the PS3H122SZX and PS3H122SZX2 focus systems couple indirectly to the fine focus knob of the microscope via a friction pad. The SZX is compatible with the SZX7, SZX9 and SZX12. The SZX2 is compatible with the SZX10 and SZX16. SZX microscopes must be fitted with a fine focus actuator for a Prior motorized focus to be added.

Part	Description
PS3H122SZX	Focus drive assembly, PS3, Evident/Olympus SZX 7/9/12
PS3H122SZX2	Focus drive assembly, PS3, Evident/Olympus SZX 10/16

Illumination

The L200OL and L200SOL are recommended for fluorescence microscopy (see [datasheet](#) for details). The L200SOL has a built in shutter mechanism which can be controlled via a ProScan III controller, so a standalone shutter is not required. The L220OL and L220SOL are available for customers doing fluorescence imaging in the far-red. Addition of these illuminators requires the SZX-RFA, SZX-RFA2-16 or SZX-RFA2-16A fluorescence illuminator.

Part	Description
L200SOL	L200 standard box, lamp, light guide, shutter and Evident/Olympus collimator
L200OL	L220 standard box, lamp, light guide and Evident/Olympus collimator
L220SOL	L220 standard box, lamp, light guide, shutter and Evident/Olympus collimator
L220OL	L220 standard box, lamp, light guide and Evident/Olympus collimator

Excitation path

Filter wheels are not supplied with filters. Contact Prior Scientific if you wish to purchase a filter wheel stand that can be fixed to an optical table. For systems requiring a shutter and filter wheel it is recommended to buy one of the combinations listed above. The HF260 adapter is required for filter wheels and shutters in the episcopic illumination pathway.

Part	Description
HF260	Filter wheel adapter for Evident/Olympus BX, IX and AX series microscopes
HF202HT	25 mm high temperature standalone shutter
HF204HT	35 mm high temperature standalone shutter
HF110A	Filter wheel, 10 position, 25 mm diameter filters without stand
HF110	Filter wheel, 10 position, 25 mm diameter filters with stand
HF106A	Filter wheel, 6 position, 25 mm diameter filters without stand
HF108A	Filter wheel, 8 position, 32 mm diameter filters without stand
HF108	Filter wheel, 8 position, 32 mm diameter filters with stand
HF110A + HF200HT	10 position 25 mm diameter filter wheel plus shutter combination
HF108A + HF201HT	8 position 32 mm diameter filter wheel plus shutter combination